

> **Features**

- High Current
- Low On-Resistance
- No Secondary Breakdown
- Low Driving Power
- High Forward Transconductance
- Avalanche Proof

> **Applications**

- Motor Control
- General Purpose Power Amplifier
- DC-DC converters

> **Outline Drawing**

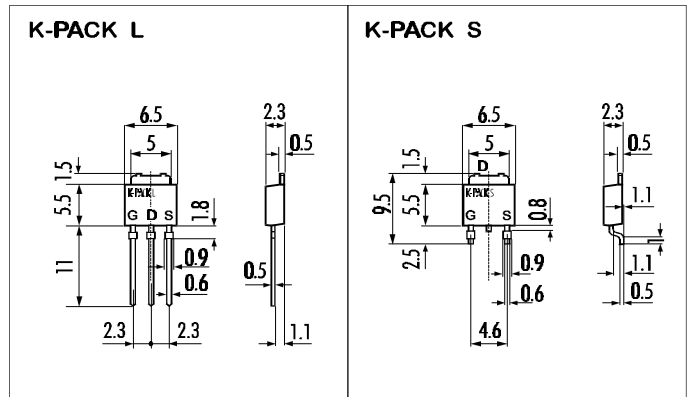

> **Maximum Ratings and Characteristics**

- Absolute Maximum Ratings ($T_C=25^\circ\text{C}$), unless otherwise specified

Item	Symbol	Rating	Unit
Drain-Source-Voltage	V_{DS}	60	V
Drain-Gate-Voltage($R_{GS}=20K\Omega$)	V_{DGR}	60	V
Continous Drain Current	I_D	10	A
Pulsed Drain Current	$I_{D(puls)}$	40	A
Gate-Source-Voltage	V_{GS}	± 20	V
Max. Power Dissipation	P_D	20	W
Operating and Storage Temperature Range	T_{ch}	150	$^\circ\text{C}$
	T_{stg}	-55 ~ +150	$^\circ\text{C}$

> **Equivalent Circuit**

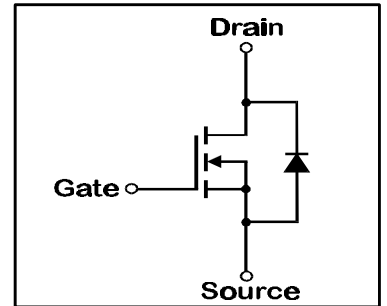

- Electrical Characteristics ($T_C=25^\circ\text{C}$), unless otherwise specified

Item	Symbol	Test conditions	Min.	Typ.	Max.	Unit
Drain-Source Breakdown-Voltage	$V_{(BR)DSS}$	$I_D=1\text{mA}$ $V_{GS}=0\text{V}$	60			V
Gate Threshold Voltage	$V_{GS(th)}$	$I_D=1\text{mA}$ $V_{DS}=V_{GS}$	1,0	1,5	2,5	V
Zero Gate Voltage Drain Current	I_{DSS}	$V_{DS}=60\text{V}$ $T_{ch}=25^\circ\text{C}$		10	500	μA
		$V_{GS}=0\text{V}$ $T_{ch}=125^\circ\text{C}$		0,2	1,0	mA
Gate Source Leakage Current	I_{GSS}	$V_{GS}=\pm 20\text{V}$ $V_{DS}=0\text{V}$		10	100	nA
Drain Source On-State Resistance	$R_{DS(on)}$	$I_D=5\text{A}$ $V_{GS}=4\text{V}$		0,11	0,16	Ω
		$I_D=5\text{A}$ $V_{GS}=10\text{V}$		0,07	0,1	Ω
Forward Transconductance	g_{fs}	$I_D=5\text{A}$ $V_{DS}=25\text{V}$	4	8		S
Input Capacitance	C_{iss}	$V_{DS}=25\text{V}$		500	750	pF
Output Capacitance	C_{oss}	$V_{GS}=0\text{V}$		200	300	pF
Reverse Transfer Capacitance	C_{rss}	$f=1\text{MHz}$		80	120	pF
Turn-On-Time t_{on} ($t_{on}=t_{d(on)}+t_r$)	$t_{d(on)}$	$V_{CC}=30\text{V}$		10	15	ns
		$I_D=5\text{A}$		20	30	ns
Turn-Off-Time t_{off} ($t_{off}=t_{d(off)}+t_f$)	$t_{d(off)}$	$V_{GS}=10\text{V}$		100	150	ns
		$R_{GS}=25\Omega$		50	75	ns
Avalanche Capability	I_{AV}	$L=100\mu\text{H}$ $T_{ch}=25^\circ\text{C}$	10			A
Continous Reverse Drain Current	I_{DR}				10	A
Pulsed Reverse Drain Current	I_{DRM}				40	A
Diode Forward On-Voltage	V_{SD}	$I_F=2I_{DR}$ $V_{GS}=0\text{V}$ $T_{ch}=25^\circ\text{C}$		1,2		V
Reverse Recovery Time	t_{rr}	$I_F=I_{DR}$ $V_{GS}=0\text{V}$		100		ns
Reverse Recovery Charge	Q_{rr}	$-di_F/dt=100\text{A}/\mu\text{s}$ $T_{ch}=25^\circ\text{C}$		0,15		μC

- Thermal Characteristics

Item	Symbol	Test conditions	Min.	Typ.	Max.	Unit
Thermal Resistance	$R_{th(ch-a)}$	channel to air				$^\circ\text{C}/\text{W}$
	$R_{th(ch-c)}$	channel to case			6,25	$^\circ\text{C}/\text{W}$

> Characteristics

Typical Output Characteristics

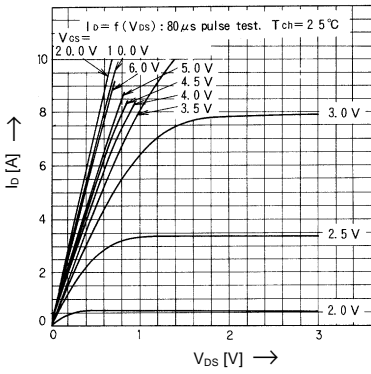

Drain-Source-On-State Resistance vs. Tch

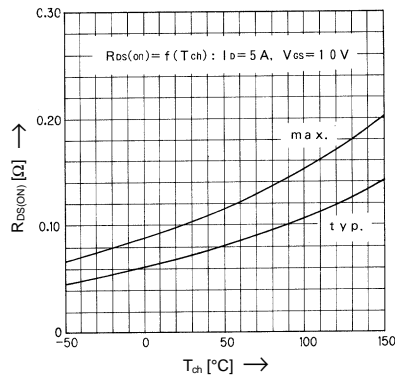

Typical Transfer Characteristics

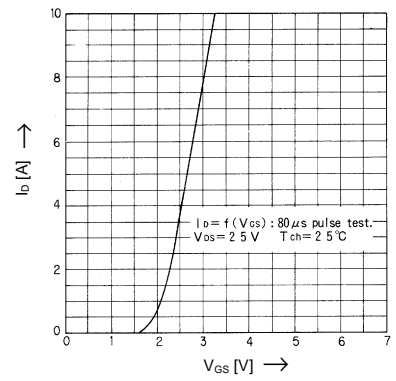

Typical Drain-Source-On-State-Resistance vs. Id

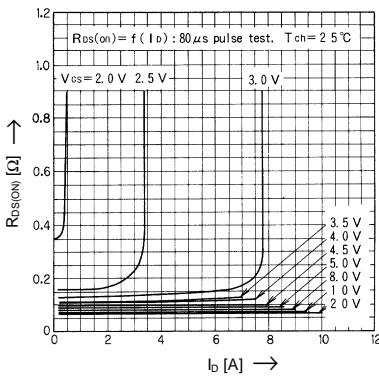

Typical Forward Transconductance vs. Id

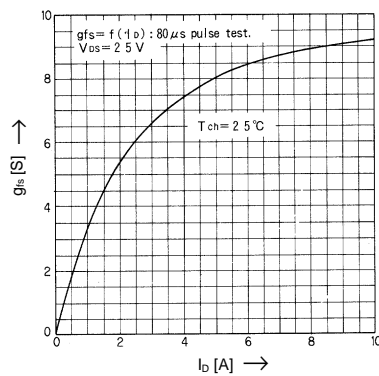

Gate Threshold Voltage vs. Tch

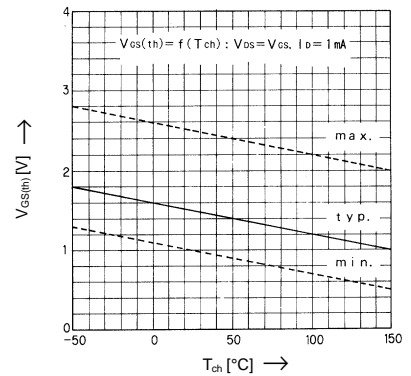

Typical Capacitance vs. Vds

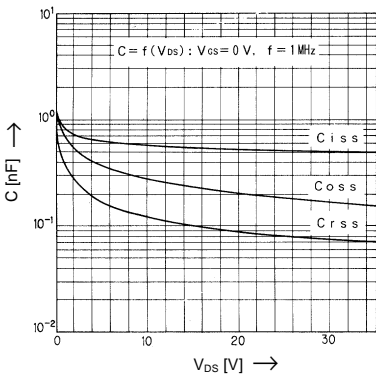

Typical Input Charge

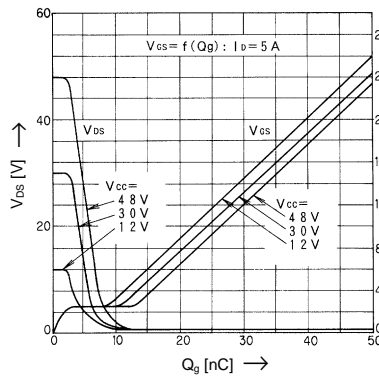

Forward Characteristics of Reverse Diode

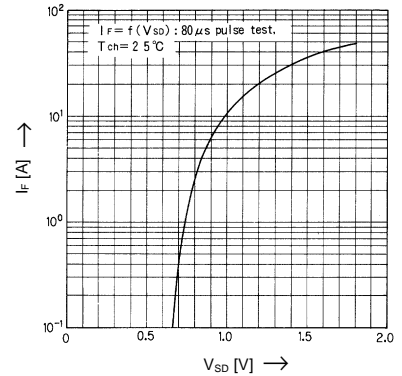

Allowable Power Dissipation vs. Tch

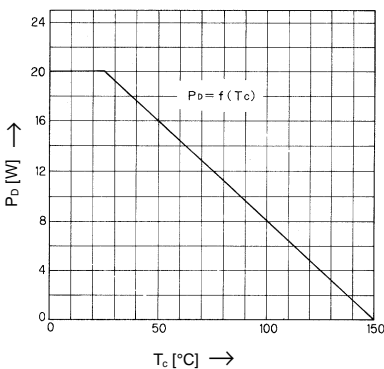

Safe operation area

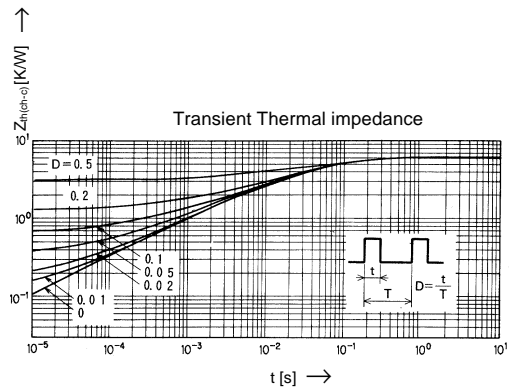
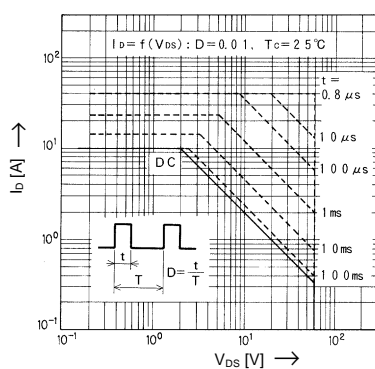

This datasheet has been download from:

www.datasheetcatalog.com

Datasheets for electronics components.